

Photoelectric Beam Detector
SASO-PB10S/PB30S/PB60S

Please note : This sensor is designed to detect intrusion and to initiate an alarm, it is not a burglar-preventing device. Maker is not responsible for damage, injury or losses caused by accident, theft, natural disasters, abuse, misuse, abnormal usage, faulty installation or improper maintenance.

1. Description

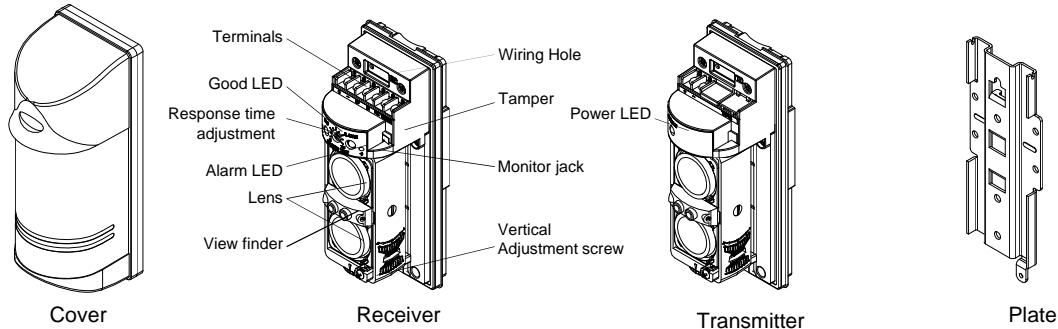

2. Cautions on Installation

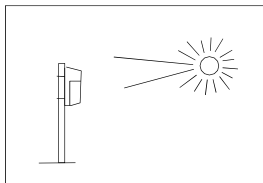

Avoid strong light from sun, automobile head-lights etc. shining on transmitter or receiver

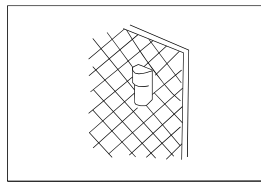

Do not install the unit on unsteady surfaces.

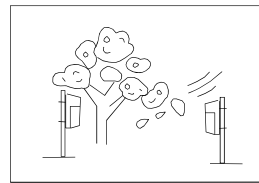

Do not install in a site where beam may be interrupted by trees or plants, consider seasonal changes.

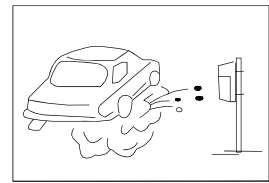

Do not install in places where units may be splashed continuously by dirty water or direct sea spray.

3. Installation Hints

3-1. Wall mount

- ① Remove cover from unit and slide the mounting plate to detach it.
- ② Break grommet on mounting plate and pull wire through it. Secure the plate with 4mm screws.
- ③ When exposed wired, break knock-outs on the rear of unit, pull wire through as the figure and attach it to the mounting plate.
- ④ After wiring is completed, adjust alignment, check operation and attach cover.

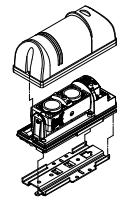
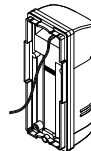
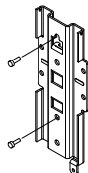
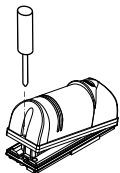

3-2. Pole mount (Pole size : $\Phi 38$ ~ $\Phi 44$ mm)

- ① Remove cover from unit and slide the mounting plate to detach it.
- ② Attach pole brackets to pole and secure to mounting plate with screws.
- ③ Attach sensor body.
- ④ Pull through wire.
- ⑤ Connect terminals.
- ⑥ After wiring is completed, adjust alignment, check operation and attach cover.

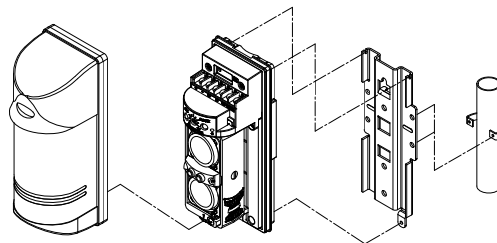

4. Response time

Response time adjustment

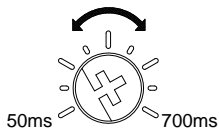

1. Run at full speed (6.9m/s) - 50msec.



2. Walk with quick steps (1.2m/s) - 200msec.



3. Walking (0.7m/s) - 300msec.



4. Walk with slow steps (0.5m/s) - 500msec.



5-6. Go over a fence(0.3m/s) - 700msec.



5. Terminal Arrangement

Receiver

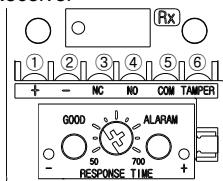

Transmitter

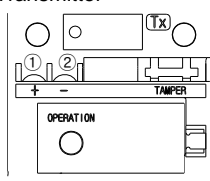

NO	Usage	NO	Usage
1	VCC	4	Normal Open
2	GND	5	Common
3	Normal Close	6	Tamper

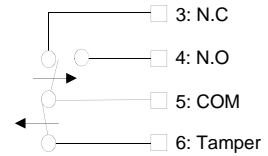

6. Adjustment and Monitoring

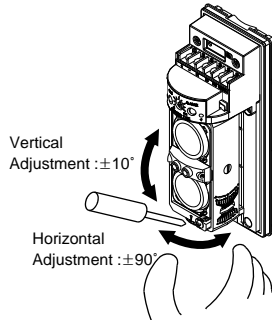

Look through view finder on either side and line-up optics horizontally and vertically until the opposite unit is visible.

- Monitoring

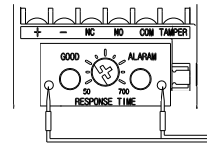

Digital Multi meter

Monitoring	R:Green LED	Condition
Less than 3.0V	OFF	Alignment again
3.0 ~ 3.7V	ON	Alignment Good
3.7 ~ 4V	ON	Very Good

7. Trouble Shooting

	Problem	Possible cause	Possible Solution
Tx	Power LED dose not light.	No power supply. Bad wiring connection or short.	Input DC 10.8 ~18V. Check wiring connection and repair if necessary.
Rx	Alarm LED does not light when two beams are broken simultaneously.	No power supply. Bad wiring connection or short.	
	No contact under the set condition	Resistor short.	Replace.
	Good LED does not operate	Malfunction	Replace.

8. Specifications & Dimension

Model	SASO-PB10S	SASO-PB30S	SASO-PB60S
Detection system	Simultaneous breaking of 2 beams		
Infrared beam	Double modulation pulsed beams by LED		
Protection range	Outdoor 10m Indoor 30m	Outdoor 30m Indoor 60m	Outdoor 60m Indoor 120m
Max. beam range	Outdoor 100m Indoor 100m	Outdoor 300m Indoor 300m	Outdoor 600m Indoor 600m
Supply voltage	10.8V ~ 18V DC(Non-polarity)		
Current	57mA	57mA	57mA
Response time	50msec to 700msec		
LED	Transmitter	Green LED ON : Power ON	
	Receiver	Green LED(Sensitivity Good) / Red ON : When an alarm is initiated	
Alarm output	Dry contact relay output form C Contact action : Interruption time + delay time(1~3 sec) Contact capacity : 30V(AC/DC) 1A or less		
Tamper output	Dry contact relay output form N/C(Receiver only) Contact action : Activated when cover is detached Contact capacity : 30V(AC/DC) 1A or less		
Temperature	-20°C ~ 60°C		
Beam adjustment	Horizontal : 180° (±90°), Vertical : 20° (±10°)		
Mounting position	Out door / In door		
Material	PC resin(Green)		
IP rating	IP 44		
External dimensions	63 x 163 x 75mm(WxHxD)		
Weight	Rx : 326g, Tx : 309g	Rx : 330g, Tx : 315g	
Function	Monitor jack output, Frost proof cover		
Option	Pole attachment(2pcs./set) / Transmitter tamper switch / IP 54		

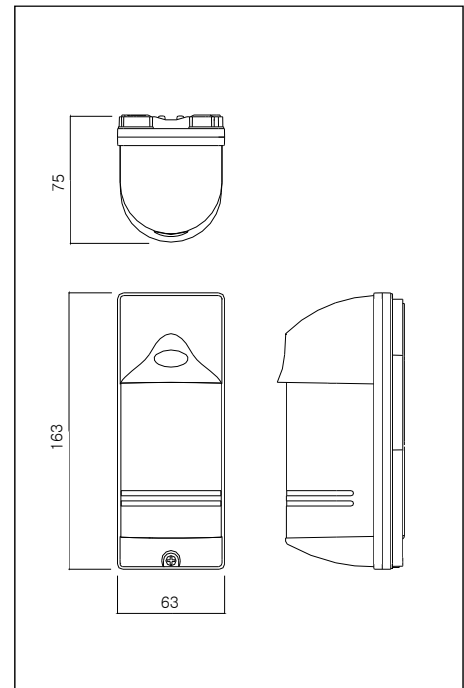

* Caution : Please consult the instruction manual to ensure safe and proper operation of the product. Specification and design are subject to change without prior notice for improvement.



1141 Budapest, Fogarasi út 77. 1095 Budapest, Mester u. 34.
Tel.: *220-7940, 220-8881, 220-7959. Tel.: *218-5542, 215-9771, 215-7550,
220-7814, 364-3428 Fax: 220-7940 218-7017, 216-7018 Fax: 218-5542
Mobil: 30 531-5454, 30 939-9989 Mobil: 30 940-1970, 20 949-2688

E-mail: delton@delton.hu Web: www.delton.hu

www.saso.hu